

# FLOWER POWER

design ridea

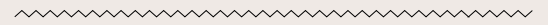

Una scultura, un complemento d'arredo. Il design unito alla funzionalità, una forma emblematica: un cerchio dentro un altro cerchio, un occhio, una finestra virtuale sull'infinito. I motivi floreali ricordano le suggestioni della natura.



A sculpture, a furnishing complement. The design joined together to the functionality, an emblematic shape: a circle inside another circle, an eye, a virtual window over the infinite. The grooves of the floral patterns remember the nature's power.





*Finitura fotografata in queste pagine:  
Noir 900 Sablè.*

*Nella pagina accanto:  
Blu cielo RAL 5015.*

*Finish photographed on this page:  
Noir 900 Sablè.*

*On the opposite page:  
Blu cielo RAL 5015.*

# FLOWER POWER

hxb (cm)	n numero elementi/ elements number	peso a vuoto/ weight empty (kg)	volume d'acqua/ water volume (dm <sup>3</sup> )	a (cm)	c (cm)	d (cm)	e (cm)	Qs resa termica/ thermal yield □t 50°C (watt)	Q potenza elettrica/ electrical power (watt)	versione mista* / combined version*	fissa / not opening	apribile / opening
												
<b>verticale/vertical</b>												
80,0x80,0	1	12,0	0,19	32,0	28,0	20,0	40,0	506	480	•	-	•
100,0x100,0	1	19,0	0,3	42,0	38,0	30,0	50,0	727	720	•	-	•

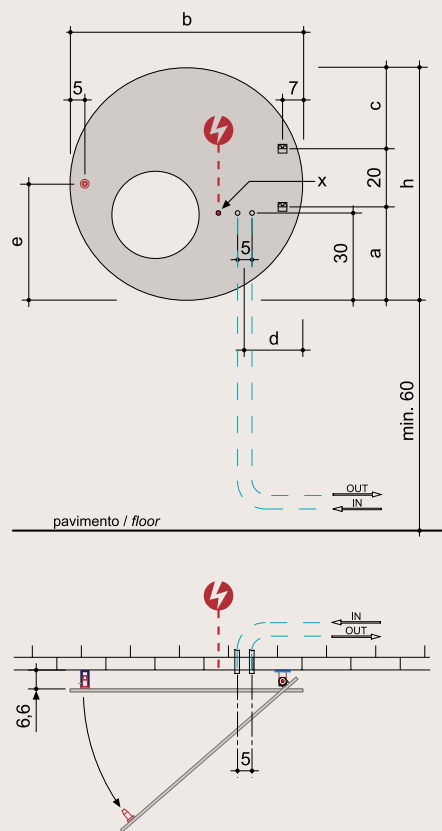

- \*.  
a richiesta con sovrapprezzo
- X.**  
posizione ingresso a muro del  
cavo (per versione elettrica  
e mista)
- ~~~~~
- \*.  
upon request with surcharge
- X.**  
electrical wire wall entry  
position (for electric and  
mixed version)